

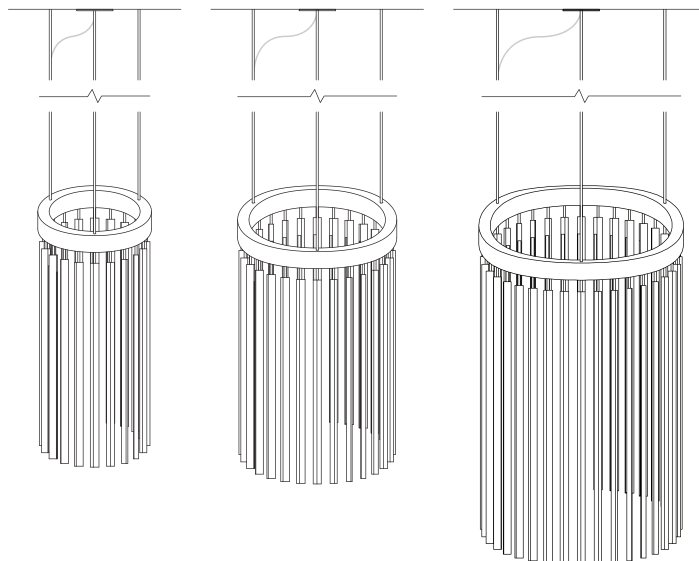

SINGLE CHIME

ALL SIZES SPEC SHEET



FRONT

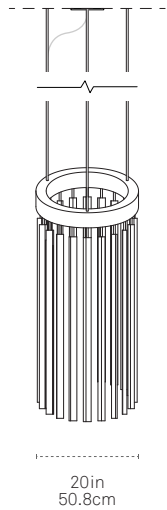

SIDE

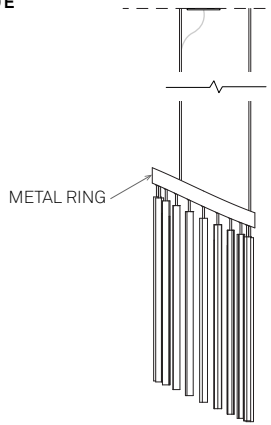

PLAN

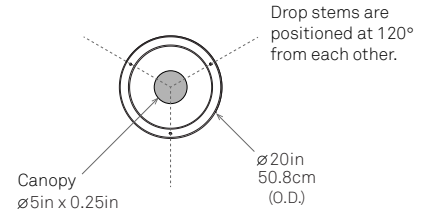

□ Bulb Profile
0.81in x 1.31in
2.1cm x 3.3cm

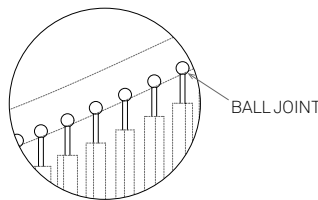

All Chime fixtures feature a 360° BALL JOINT that allows each bulb to rotate within its socket.

SPECIFY PRODUCT OPTIONS:

MODEL

L3-CHM

WOOD	METAL	COLOR TEMP	DRIVER	OUTPUT	STEM
<input type="checkbox"/>	<input type="checkbox"/>	<input type="checkbox"/>	<input type="checkbox"/>	<input type="checkbox"/>	<input type="checkbox"/>

DESIGN

© 2019

MATERIALS

LED, Sustainably Sourced or Reclaimed Wood, Steel

FEATURES

UL Damp Rated
Fully Dimmable
360° ball joint allows each bulb to rotate within its socket

CERTIFICATIONS



ORIGIN OF MANUFACTURE

New York City, USA

FIXTURE WEIGHT

43 lbs / 19.5 kg

SHIPPING DIMENSIONS

Shipping dimensions TBD based on order details.

LIGHT SPECIFICATION

Standard Brightness LEDs :
3,898 Lumens / 94 CRI (3000K) /
126W Power draw

WOOD*

STANDARD

Maple	<input type="checkbox"/>	<input type="checkbox"/>	<input type="checkbox"/>	<input type="checkbox"/>	<input type="checkbox"/>	<input type="checkbox"/>	<input type="checkbox"/>
American Walnut	<input type="checkbox"/>	<input type="checkbox"/>	<input type="checkbox"/>	<input type="checkbox"/>	<input type="checkbox"/>	<input type="checkbox"/>	<input type="checkbox"/>
Ebonized Oak	<input type="checkbox"/>	<input type="checkbox"/>	<input type="checkbox"/>	<input type="checkbox"/>	<input type="checkbox"/>	<input type="checkbox"/>	<input type="checkbox"/>

PREMIUM

Heart Pine (Reclaimed)**	<input type="checkbox"/>	<input type="checkbox"/>	<input type="checkbox"/>	<input type="checkbox"/>	<input type="checkbox"/>	<input type="checkbox"/>	<input type="checkbox"/>
Water Tower Redwood (Reclaimed)**	<input type="checkbox"/>	<input type="checkbox"/>	<input type="checkbox"/>	<input type="checkbox"/>	<input type="checkbox"/>	<input type="checkbox"/>	<input type="checkbox"/>
Clear White Oak	<input type="checkbox"/>	<input type="checkbox"/>	<input type="checkbox"/>	<input type="checkbox"/>	<input type="checkbox"/>	<input type="checkbox"/>	<input type="checkbox"/>

* Custom options available upon approval.

** Our reclaimed woods exhibit variations in tone and grain.

METAL*

METAL RING FINISH

Matte Black Powder Coat**	<input type="checkbox"/>	<input type="checkbox"/>	<input type="checkbox"/>	<input type="checkbox"/>	<input type="checkbox"/>	<input type="checkbox"/>	<input type="checkbox"/>
---------------------------	--------------------------	--------------------------	--------------------------	--------------------------	--------------------------	--------------------------	--------------------------

* Custom options available upon approval.

** Matte Black canopy, black fabric chord, polished nickel ball joint

COLOR TEMP

2400K	<input type="checkbox"/>	<input type="checkbox"/>	<input type="checkbox"/>	<input type="checkbox"/>	<input type="checkbox"/>	<input type="checkbox"/>	<input type="checkbox"/>
2700K	<input type="checkbox"/>	<input type="checkbox"/>	<input type="checkbox"/>	<input type="checkbox"/>	<input type="checkbox"/>	<input type="checkbox"/>	<input type="checkbox"/>
3000K (Standard)	<input type="checkbox"/>	<input type="checkbox"/>	<input type="checkbox"/>	<input type="checkbox"/>	<input type="checkbox"/>	<input type="checkbox"/>	<input type="checkbox"/>
3500K	<input type="checkbox"/>	<input type="checkbox"/>	<input type="checkbox"/>	<input type="checkbox"/>	<input type="checkbox"/>	<input type="checkbox"/>	<input type="checkbox"/>
4000K	<input type="checkbox"/>	<input type="checkbox"/>	<input type="checkbox"/>	<input type="checkbox"/>	<input type="checkbox"/>	<input type="checkbox"/>	<input type="checkbox"/>

DRIVER & DIMMING OPTIONS

0-10V dimming*	<input type="checkbox"/>	<input type="checkbox"/>	<input type="checkbox"/>	<input type="checkbox"/>	<input type="checkbox"/>	<input type="checkbox"/>	<input type="checkbox"/>
----------------	--------------------------	--------------------------	--------------------------	--------------------------	--------------------------	--------------------------	--------------------------

*See Driver Information page.
For phase dimming options (Triac & ELV) please inquire.

LIGHT OUTPUT

Standard Brightness - 12V (Dimmable)	<input type="checkbox"/>	<input type="checkbox"/>	<input type="checkbox"/>	<input type="checkbox"/>	<input type="checkbox"/>	<input type="checkbox"/>	<input type="checkbox"/>
--------------------------------------	--------------------------	--------------------------	--------------------------	--------------------------	--------------------------	--------------------------	--------------------------

STEM LENGTH *

Segmented length of rigid steel stem **	<input type="checkbox"/>	<input type="checkbox"/>	<input type="checkbox"/>	<input type="checkbox"/>	<input type="checkbox"/>	<input type="checkbox"/>	<input type="checkbox"/>
3/8"ø	<input type="checkbox"/>	<input type="checkbox"/>	<input type="checkbox"/>	<input type="checkbox"/>	<input type="checkbox"/>	<input type="checkbox"/>	<input type="checkbox"/>

* See stem length guideline page to calculate stem length.

Minimum stem length 5"

** Length written in inches in corresponding box



FRONT

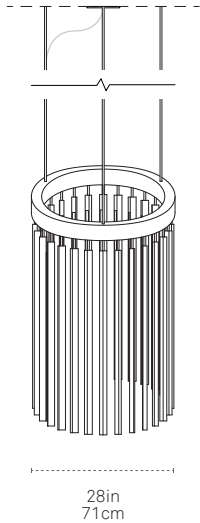

SIDE

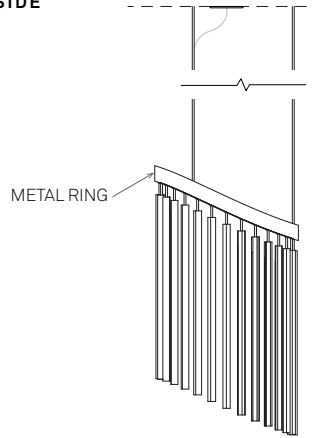

PLAN

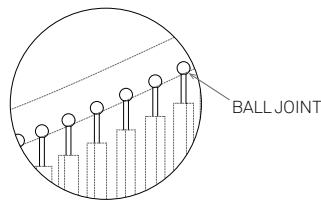
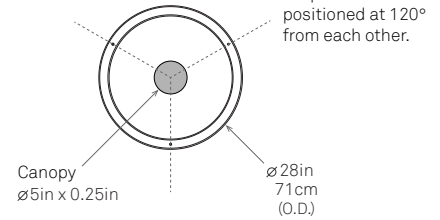

All Chime fixtures feature a 360° BALL JOINT that allows each bulb to rotate within its socket.

SPECIFY PRODUCT OPTIONS:

MODEL

M3-CHM

WOOD

METAL

COLOR TEMP

DRIVER

OUTPUT

STEM

DESIGN

© 2019

MATERIALS

LED, Sustainably Sourced or Reclaimed Wood, Steel

FEATURES

UL Damp Rated
Fully Dimmable
360° ball joint allows each bulb to rotate within its socket

CERTIFICATIONS



ORIGIN OF MANUFACTURE

New York City, USA

FIXTURE WEIGHT

58 lbs / 26.3 kg

SHIPPING DIMENSIONS

Shipping dimensions TBD based on order details.

LIGHT SPECIFICATION

Standard Brightness LEDs :
5,457 Lumens / 94 CRI (3000K) /
176W Power draw

WOOD*

STANDARD

Maple

M A

American Walnut

W A

Ebonized Oak

E O

PREMIUM

Heart Pine (Reclaimed)**

H P

Water Tower Redwood (Reclaimed)**

W T

Clear White Oak

C W

* Custom options available upon approval.

** Our reclaimed woods exhibit variations in tone and grain.

METAL*

METAL RING FINISH

Matte Black Powder Coat**

M B

* Custom options available upon approval.

** Matte Black canopy, black fabric chord, polished nickel ball joint

COLOR TEMP

2400K

2 4 0 0

2700K

2 7 0 0

3000K (Standard)

3 0 0 0

3500K

3 5 0 0

4000K

4 0 0 0

DRIVER & DIMMING OPTIONS

0-10V dimming*

0 1 0

*See Driver Information page.

For phase dimming options (Triac & ELV) please inquire.

LIGHT OUTPUT

Standard Brightness - 12V (Dimmable)

S B

STEM LENGTH *

Segmented length of rigid steel stem **

X X X

3/8"ø

(inches)

* See stem length guideline page to calculate stem length.

Minimum stem length 5"

** Length written in inches in corresponding box



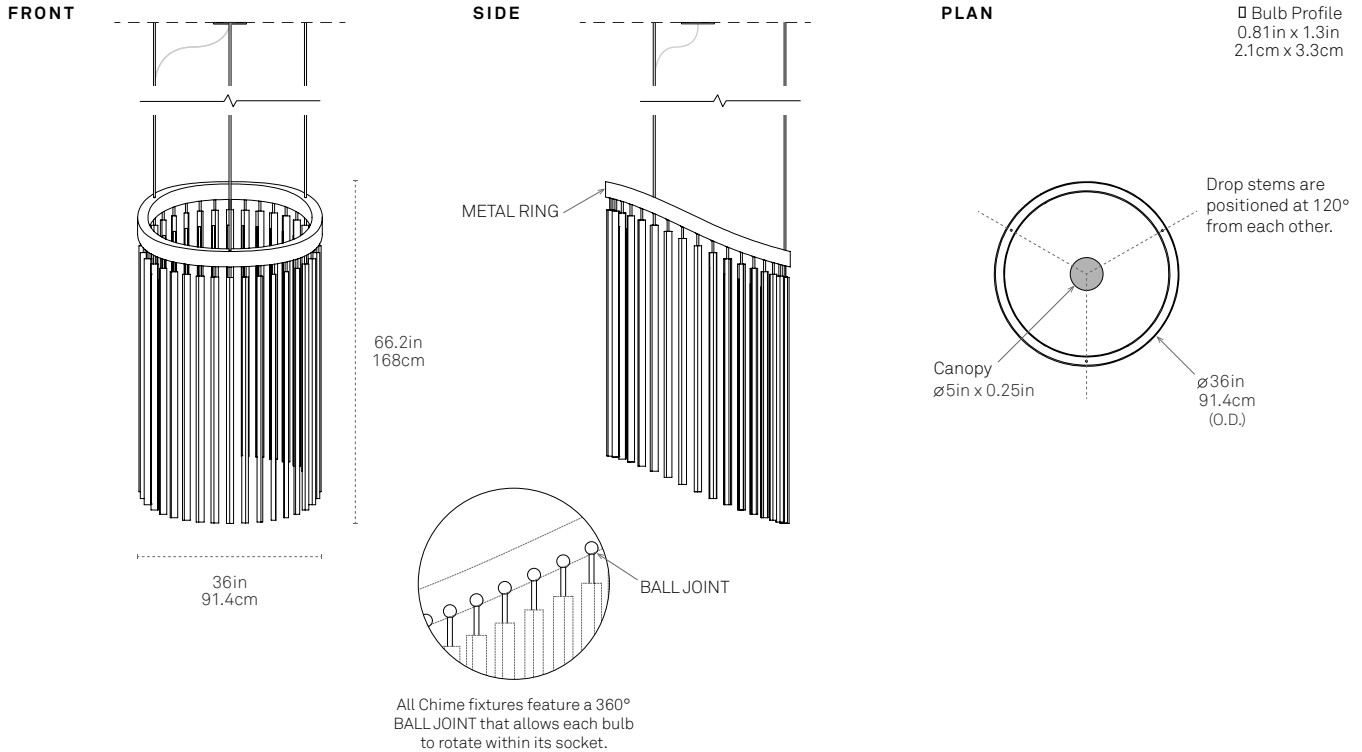

SPECIFY PRODUCT OPTIONS:

MODEL

B4-CHM

WOOD

--	--

METAL

--	--

COLOR TEMP

--	--	--	--

DRIVER

--	--

OUTPUT

--	--

STEM

--	--	--	--

DESIGN

© 2019

MATERIALS

LED, Sustainably Sourced or Reclaimed Wood, Steel

FEATURES

UL Damp Rated
Fully Dimmable
360° ball joint allows each bulb to rotate within its socket

CERTIFICATIONS



ORIGIN OF MANUFACTURE

New York City, USA

FIXTURE WEIGHT

88 lbs / 39.9 kg

SHIPPING DIMENSIONS

Shipping dimensions TBD based on order details.

LIGHT SPECIFICATION

Standard Brightness LEDs :
9,540 Lumens / 94 CRI (3000K) /
308W Power draw

WOOD*

STANDARD

Maple

M A

American Walnut

W A

Ebonized Oak

E O

PREMIUM

Heart Pine (Reclaimed)**

H P

Water Tower Redwood (Reclaimed)**

W T

Clear White Oak

C W

* Custom options available upon approval.

** Our reclaimed woods exhibit variations in tone and grain.

METAL*

METAL RING FINISH

Matte Black Powder Coat**

M B

* Custom options available upon approval.

** Matte Black canopy, black fabric chord, polished nickel ball joint

COLOR TEMP

2400K

2 4 0 0

2700K

2 7 0 0

3000K (Standard)

3 0 0 0

3500K

3 5 0 0

4000K

4 0 0 0

DRIVER & DIMMING OPTIONS

0-10V dimming*

0 1 0

*See Driver Information page.

For phase dimming options (Triac & ELV) please inquire.

LIGHT OUTPUT

Standard Brightness - 12V (Dimmable)

S B

STEM LENGTH*

Segmented length of rigid steel stem **

X X X
(inches)

* See stem length guideline page to calculate stem length.

Minimum stem length 5"

** Length written in inches in corresponding box



ALTERNATE CONFIGURATIONS

Occasionally our products have unlisted variations. If you are interested in an alternate configuration, please reach out to orders@stickbulb.com



FRONT

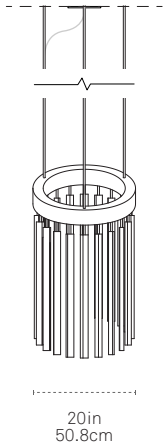

SIDE

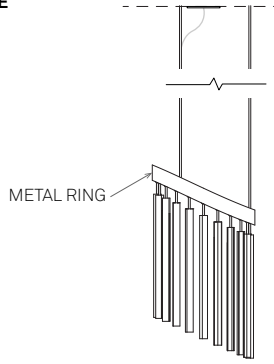

PLAN

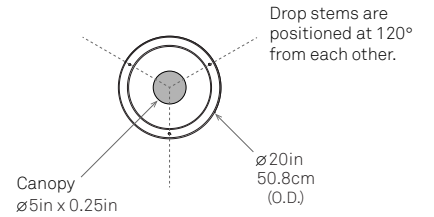

□ Bulb Profile
0.81in x 1.3in
2.1cm x 3.3cm

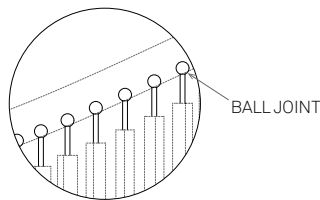

All Chime fixtures feature a 360° BALL JOINT that allows each bulb to rotate within its socket.

SPECIFY PRODUCT OPTIONS:

MODEL

L2-CHM

WOOD

METAL

COLOR TEMP

DRIVER

OUTPUT

STEM

DESIGN

© 2019

MATERIALS

LED, Sustainably Sourced or Reclaimed Wood, Steel

FEATURES

UL Damp Rated
Fully Dimmable
360° ball joint allows each bulb to rotate within its socket

CERTIFICATIONS



ORIGIN OF MANUFACTURE

New York City, USA

FIXTURE WEIGHT

34 lbs / 15.4 kg

SHIPPING DIMENSIONS

Shipping dimensions TBD based on order details.

LIGHT SPECIFICATION

Standard Brightness LEDs :
2,480 Lumens / 94 CRI (3000K) /
80W Power draw

WOOD*

STANDARD

Maple

M A

American Walnut

W A

Ebonized Oak

E O

PREMIUM

Heart Pine (Reclaimed)**

H P

Water Tower Redwood (Reclaimed)**

W T

Clear White Oak

C W

* Custom options available upon approval.

** Our reclaimed woods exhibit variations in tone and grain.

METAL*

METAL RING FINISH

Matte Black Powder Coat**

M B

* Custom options available upon approval.

** Matte Black canopy, black fabric chord, polished nickel ball joint

COLOR TEMP

2400K

2 4 0 0

2700K

2 7 0 0

3000K (Standard)

3 0 0 0

3500K

3 5 0 0

4000K

4 0 0 0

DRIVER & DIMMING OPTIONS

0-10V dimming*

0 1 0

*See Driver Information page.

For phase dimming options (Triac & ELV) please inquire.

LIGHT OUTPUT

Standard Brightness - 12V (Dimmable)

S B

STEM LENGTH *

Segmented length of rigid steel stem **

X X X

3/8"ø

(inches)

* See stem length guideline page to calculate stem length.

Minimum stem length 5"

** Length written in inches in corresponding box



FRONT

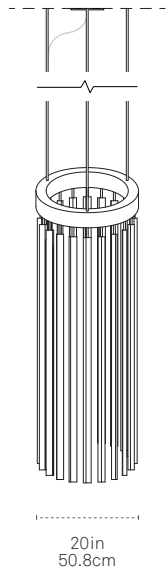

SIDE

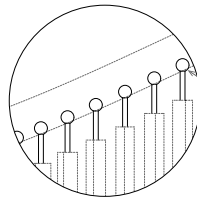
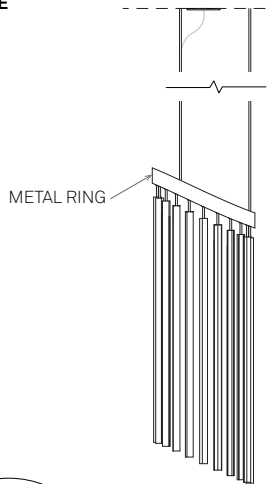

All Chime fixtures feature a 360° BALL JOINT that allows each bulb to rotate within its socket.

PLAN

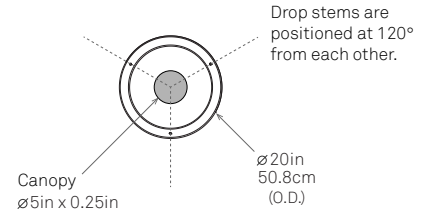

□ Bulb Profile
0.81in x 1.31in
2.1cm x 3.3cm

SPECIFY PRODUCT OPTIONS:

MODEL

L4-CHM

WOOD	METAL	COLOR TEMP	DRIVER	OUTPUT	STEM
<input type="checkbox"/>	<input type="checkbox"/>	<input type="checkbox"/>	<input type="checkbox"/>	<input type="checkbox"/>	<input type="checkbox"/>

DESIGN

© 2019

MATERIALS

LED, Sustainably Sourced or Reclaimed Wood, Steel

FEATURES

UL Damp Rated
Fully Dimmable
360° ball joint allows each bulb to rotate within its socket

CERTIFICATIONS



ORIGIN OF MANUFACTURE

New York City, USA

FIXTURE WEIGHT

49 lbs / 22.2 kg

SHIPPING DIMENSIONS

Shipping dimensions TBD based on order details.

LIGHT SPECIFICATION

Standard Brightness LEDs :
5,300 Lumens / 94 CRI (3000K) /
171W Power draw

WOOD*

STANDARD

Maple

M A

American Walnut

W A

Ebonized Oak

E O

PREMIUM

Heart Pine (Reclaimed)**

H P

Water Tower Redwood (Reclaimed)**

W T

Clear White Oak

C W

* Custom options available upon approval.

** Our reclaimed woods exhibit variations in tone and grain.

METAL*

METAL RING FINISH

Matte Black Powder Coat**

M B

* Custom options available upon approval.

** Matte Black canopy, black fabric chord, polished nickel ball joint

COLOR TEMP

2400K

2 4 0 0

2700K

2 7 0 0

3000K (Standard)

3 0 0 0

3500K

3 5 0 0

4000K

4 0 0 0

DRIVER & DIMMING OPTIONS

0-10V dimming*

0 1 0

*See Driver Information page.

For phase dimming options (Triac & ELV) please inquire.

LIGHT OUTPUT

Standard Brightness - 12V (Dimmable)

S B

STEM LENGTH *

Segmented length of rigid steel stem **
3/8"ø

X X X
(inches)

* See stem length guideline page to calculate stem length.

Minimum stem length 5"

** Length written in inches in corresponding box



FRONT

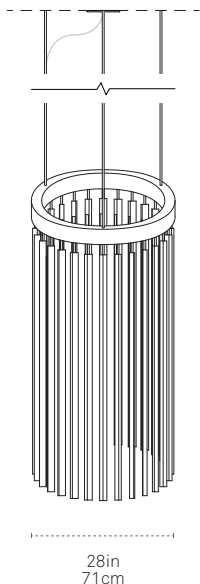

SIDE

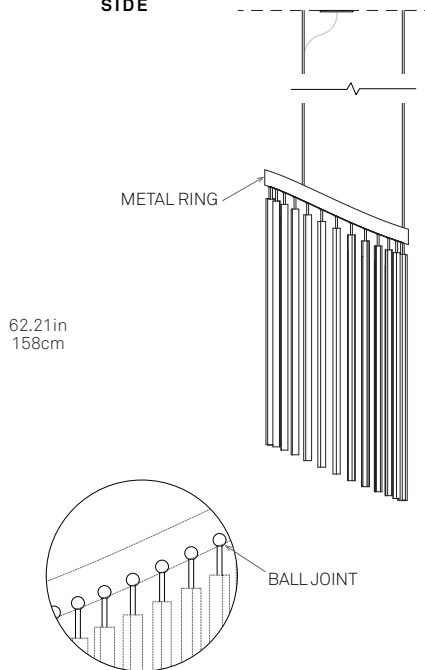

PLAN

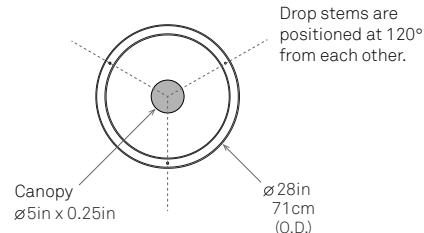

□ Bulb Profile
0.81 in x 1.31 in
2.1 cm x 3.3 cm

62.21 in
158 cm

28 in
71 cm

All Chime fixtures feature a 360° BALL JOINT that allows each bulb to rotate within its socket.

SPECIFY PRODUCT OPTIONS:

MODEL

M4-CHM

WOOD

<input type="checkbox"/>	<input type="checkbox"/>
--------------------------	--------------------------

METAL

<input type="checkbox"/>	<input type="checkbox"/>
--------------------------	--------------------------

COLOR TEMP

<input type="checkbox"/>	<input type="checkbox"/>	<input type="checkbox"/>	<input type="checkbox"/>
--------------------------	--------------------------	--------------------------	--------------------------

DRIVER

<input type="checkbox"/>	<input type="checkbox"/>	<input type="checkbox"/>
--------------------------	--------------------------	--------------------------

OUTPUT

<input type="checkbox"/>	<input type="checkbox"/>
--------------------------	--------------------------

STEM

<input type="checkbox"/>	<input type="checkbox"/>	<input type="checkbox"/>	<input type="checkbox"/>
--------------------------	--------------------------	--------------------------	--------------------------

DESIGN

© 2019

MATERIALS

LED, Sustainably Sourced or Reclaimed Wood, Steel

FEATURES

UL Damp Rated
Fully Dimmable
360° ball joint allows each bulb to rotate within its socket

CERTIFICATIONS



ORIGIN OF MANUFACTURE

New York City, USA

FIXTURE WEIGHT

67 lbs / 30.4 kg

SHIPPING DIMENSIONS

Shipping dimensions TBD based on order details.

LIGHT SPECIFICATION

Standard Brightness LEDs :
7,420 Lumens / 94 CRI (3000K) /
240W Power draw

WOOD*

STANDARD

Maple

M A

American Walnut

W A

Ebonized Oak

E O

PREMIUM

Heart Pine (Reclaimed)**

H P

Water Tower Redwood (Reclaimed)**

W T

Clear White Oak

C W

* Custom options available upon approval.

** Our reclaimed woods exhibit variations in tone and grain.

METAL*

METAL RING FINISH

Matte Black Powder Coat**

M B

* Custom options available upon approval.

** Matte Black canopy, black fabric chord, polished nickel ball joint

COLOR TEMP

2400K

2 4 0 0

2700K

2 7 0 0

3000K (Standard)

3 0 0 0

3500K

3 5 0 0

4000K

4 0 0 0

DRIVER & DIMMING OPTIONS

0-10V dimming*

0 1 0

*See Driver Information page.
For phase dimming options (Triac & ELV) please inquire.

LIGHT OUTPUT

Standard Brightness - 12V (Dimmable)

S B

STEM LENGTH *

Segmented length of rigid steel stem **
3/8"ø

X X X
(inches)

* See stem length guideline page to calculate stem length.
Minimum stem length 5"

** Length written in inches in corresponding box

FRONT

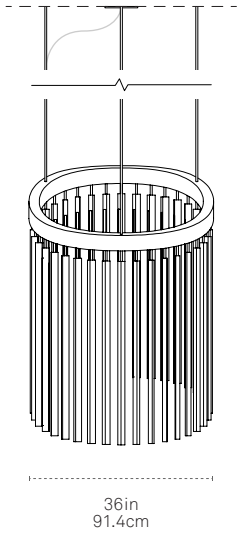

SIDE

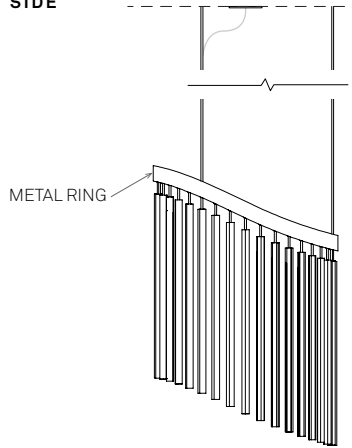

PLAN

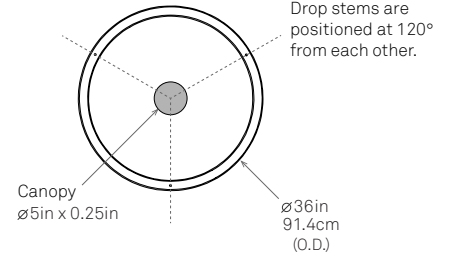

□ Bulb Profile
0.81in x 1.31in
2.1cm x 3.3cm

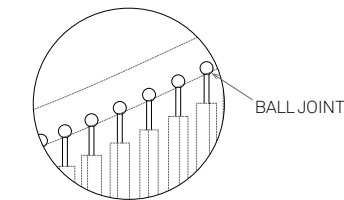

All Chime fixtures feature a 360° BALL JOINT that allows each bulb to rotate within its socket.

SPECIFY PRODUCT OPTIONS:

MODEL

B3-CHM

WOOD

METAL

COLOR TEMP

DRIVER

OUTPUT

STEM

DESIGN

© 2019

MATERIALS

LED, Sustainably Sourced or Reclaimed Wood, Steel

FEATURES

UL Damp Rated
Fully Dimmable
360° ball joint allows each bulb to rotate within its socket

CERTIFICATIONS



ORIGIN OF MANUFACTURE

New York City, USA

FIXTURE WEIGHT

70 lbs / 31.8 kg

SHIPPING DIMENSIONS

Shipping dimensions TBD based on order details.

LIGHT SPECIFICATION

Standard Brightness LEDs :
7,016 Lumens / 94 CRI (3000K) /
226W Power draw

WOOD*

STANDARD

Maple

M A

American Walnut

W A

Ebonized Oak

E O

PREMIUM

Heart Pine (Reclaimed)**

H P

Water Tower Redwood (Reclaimed)**

W T

Clear White Oak

C W

* Custom options available upon approval.

** Our reclaimed woods exhibit variations in tone and grain.

METAL*

METAL RING FINISH

Matte Black Powder Coat**

M B

* Custom options available upon approval.

** Matte Black canopy, black fabric chord, polished nickel ball joint

COLOR TEMP

2400K

2 4 0 0

2700K

2 7 0 0

3000K (Standard)

3 0 0 0

3500K

3 5 0 0

4000K

4 0 0 0

DRIVER & DIMMING OPTIONS

0-10V dimming*

0 1 0

*See Driver Information page.

For phase dimming options (Triac & ELV) please inquire.

LIGHT OUTPUT

Standard Brightness - 12V (Dimmable)

S B

STEM LENGTH *

Segmented length of rigid steel stem **

X X X
(inches)

* See stem length guideline page to calculate stem length.

Minimum stem length 5"

** Length written in inches in corresponding box



CALCULATE STEM LENGTH

$$\boxed{\text{A}} \text{ Floor to Ceiling (inches)} - \boxed{\text{B}} \text{ Drop Height (inches)} - \boxed{\text{C}} \text{ Chime Length (inches)} = \boxed{\text{D}} \text{ Stem Length (inches)}$$

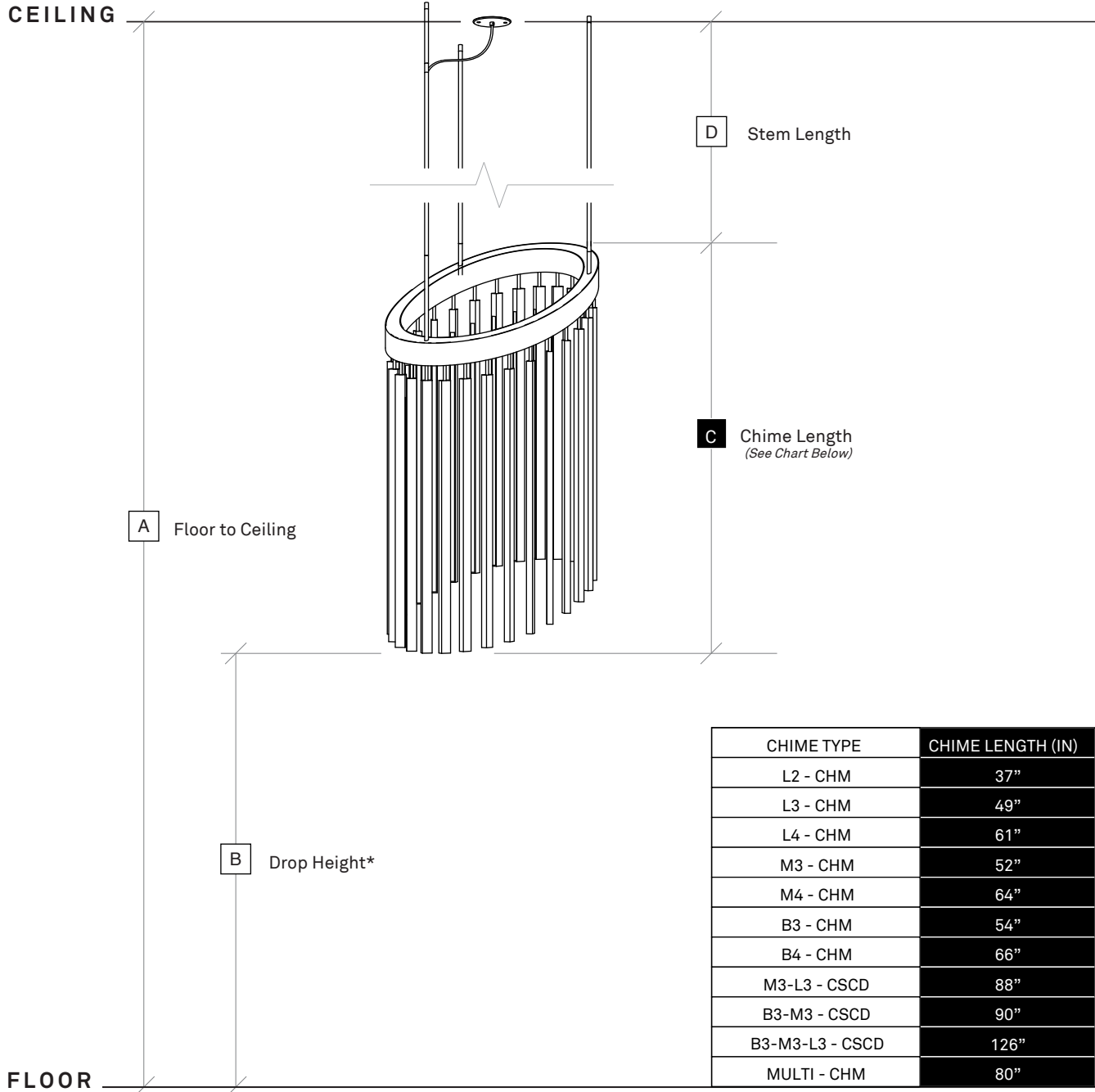

CHIME TYPE	CHIME LENGTH (IN)
L2 - CHM	37"
L3 - CHM	49"
L4 - CHM	61"
M3 - CHM	52"
M4 - CHM	64"
B3 - CHM	54"
B4 - CHM	66"
M3-L3 - CSCD	88"
B3-M3 - CSCD	90"
B3-M3-L3 - CSCD	126"
MULTI - CHM	80"

* Stickbulb recommends using the highest possible 'Drop Height.'
 We will include 3 additional segmented stem sets in 2" increments. This will allow you to drop the fixtures between 2" to 6" lower.
 ** Note: each ring requires separate AC input + dimming control



0 1 0

120V-277V driver (0-10V dimming)

Full manufacturer's specification sheets can be found at stickbulb.com/drivers/UNI25

Low-Voltage Compatible Dimmer brands: Crestron, Lutron, Leviton

For assistance selecting controls, contact LTF at +1 (847) 498-5832 or LTFsales@LTFtechnology.com

Brand	Part number
Lutron Diva	0-10V DVTV
Lutron Diva	0-10V DVTV

Brand	Part number
Leviton	IP710
Leviton	DS710
Leviton	DD710



All of our wood and metal products should be dusted by hand with a dry Swiffer pad (or equivalent) on a regular schedule to maintain surface integrity. It is imperative that none of our products come into contact with bleach, vinegar, lemon juice or any household product which may contain these or other solvents.

If any part of one of our fixtures becomes soiled with dried residue or grime, wipe the affected area with a soft cloth dampened very lightly with warm water and immediately wipe dry with another soft cloth. If this does not complete the task, wipe with a cloth soaked in diluted mild liquid dish soap and again immediately dry.

Fingerprints on our Nickel-plated, Brass-plated, and Blackened metal hardware can be removed with a clean, dry, soft cloth. We recommend an ultra-fine, textureless microfiber cleaning cloth (as one uses to clean glass).

All of our Brass hardware is treated with a protective coating to prevent tarnish. It should need no more than a wipe with a clean, dry, soft cloth to remove fingerprints and dust.

Brushed metal surfaces should be buffed in the direction of the grain.

For scratches in wood we highly recommend Claphams beeswax, which is non-toxic and can be applied by hand. Rub a small amount into the scratch area and buff with a dry cloth.

