

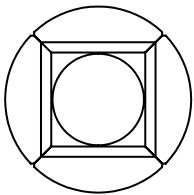

DOT

ALL



ONE DOT

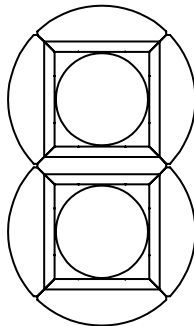

TWO DOT

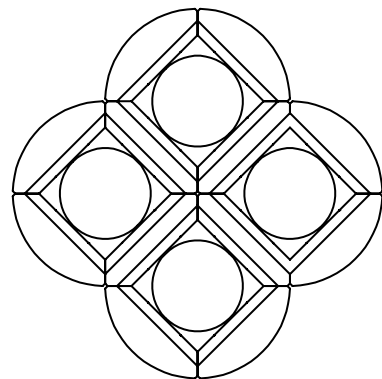

QUAD DOT



WITHOUT WALL PLATE

Requires reducer (mud ring) installed on 4"x4" octagonal J-box.

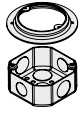
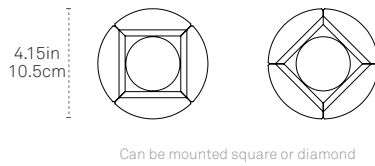

Diagram of Mud Ring on J-box

FRONT



Can be mounted square or diamond

SIDE

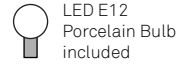
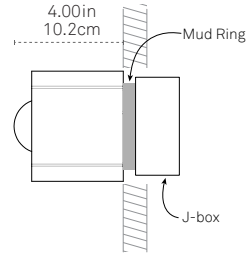

WITH WALL PLATE

Requires 4"x4" octagonal J-box



Diagram of Octagonal J-box

FRONT

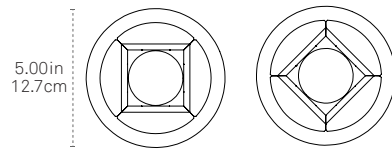

Can be mounted square or diamond

SIDE

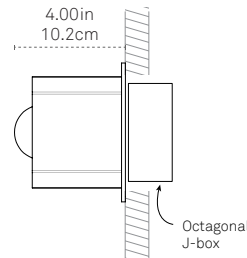

SPECIFY PRODUCT OPTIONS:

MODEL

ONE - DOT - XX - XX - XXX

WOOD

--	--

WALL PLATE

--	--

BULB

--	--	--

DESIGN

© 2024

MATERIALS

LED, Sustainably Sourced and/or Reclaimed Wood, Polished Aluminum

FEATURES

ADA Compliant
Damp Rated, PVC-Free
Dim-to-warm

CERTIFICATIONS



ORIGIN OF MANUFACTURE

New York City, USA

FIXTURE WEIGHT

1 lbs / 0.5 kg

SHIPPING DIMENSIONS

Ships in a 5" x 5" x 7" corrugated cardboard box. Dimensions and weight TBD based on order quantity.

LIGHT SPECIFICATION

120V line voltage connection. (No Driver)
LED bulb
220 Lumens
Dim-to-warm
2000k-2800k
3.8W

WOOD

Clear White Oak

C	W
---	---

White (salvaged NYC pin oak*)

W	W
---	---

Black (salvaged NYC pin oak*)

B	W
---	---

Custom

C	U
---	---

* When available, we salvage wood from NYC's fallen street and park trees to make our Pillar collection.

WALL PLATE

None (Mud Ring required)

X	X
---	---

White

W	H
---	---

Matte Black

M	B
---	---

Custom

C	U
---	---

* The metal plate behind the bulb comes in a polished aluminum finish.

BULB

Tala Sphere I E-12
Dim-to-Warm 2000k-2800k

D	2	W
---	---	---



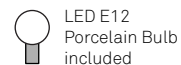

REDUCER MOUNT (MUD RING)

Requires reducer (mud ring) installed on 4"x4" octagonal J-box.

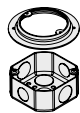
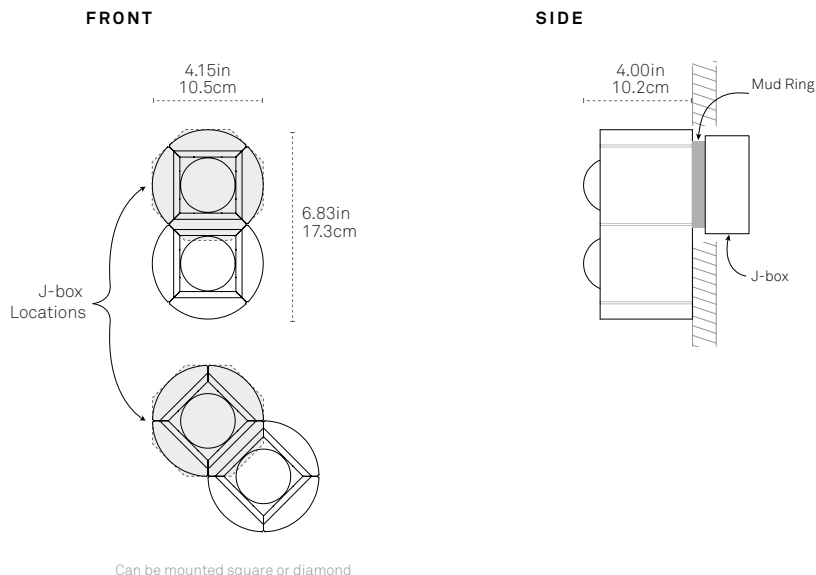

Diagram of Mud Ring on J-box



Can be mounted square or diamond

SPECIFY PRODUCT OPTIONS:

MODEL

TWO - DOT - XX - XXX

WOOD

--	--

BULB

--	--	--	--

DESIGN

© 2024

MATERIALS

LED, Sustainably Sourced and/or Reclaimed Wood, Polished Aluminum

FEATURES

ADA Compliant
Damp Rated, PVC-Free
Dim-to-warm

CERTIFICATIONS



ORIGIN OF MANUFACTURE

New York City, USA

FIXTURE WEIGHT

2lbs / 0.9 kg

SHIPPING DIMENSIONS

Ships in a corrugated cardboard box.
Dimensions and weight TBD based on order quantity.

LIGHT SPECIFICATION

120V line voltage connection.
(No Driver)
LED bulb
440 Lumens
Dim-to-warm
2000k-2800k
7.6W

WOOD

- Clear White Oak C W
- White (salvaged NYC pin oak*) W W
- Black (salvaged NYC pin oak*) B W
- Custom C U

* When available, we salvage wood from NYC's fallen street and park trees to make our Pillar collection.

BULB

- Tala Sphere I E-12 D 2 W
- Dim-to-Warm 2000k-2800k



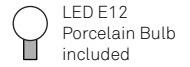

REDUCER MOUNT (MUD RING)

Requires reducer (mud ring) installed on 4"x4" octagonal J-box.

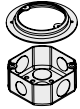
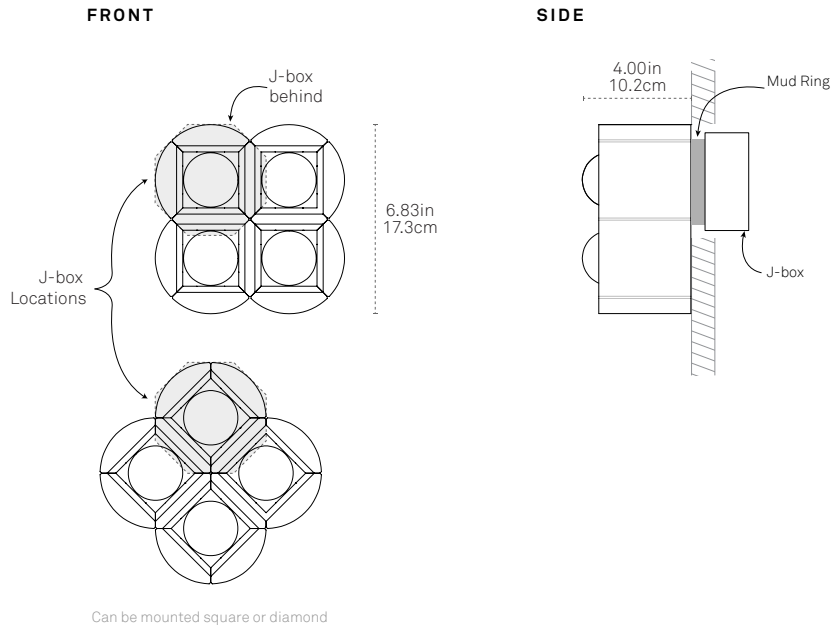

Diagram of Mud Ring on J-box



SPECIFY PRODUCT OPTIONS:

MODEL

QUAD - DOT - XX - XXX

WOOD

--	--

BULB

--	--	--	--

DESIGN

© 2024

MATERIALS

LED, Sustainably Sourced and/or Reclaimed Wood, Polished Aluminum

FEATURES

ADA Compliant
Damp Rated, PVC-Free
Dim-to-warm

CERTIFICATIONS



ORIGIN OF MANUFACTURE

New York City, USA

FIXTURE WEIGHT

4 lbs / 1.8 kg

SHIPPING DIMENSIONS

Ships in a corrugated cardboard box.
Dimensions and weight TBD based on order quantity.

LIGHT SPECIFICATION

120V line voltage connection.
(No Driver)
LED bulb
880 Lumens
Dim-to-warm
2000k-2800k
15.2W

WOOD

- Clear White Oak C W
- White (salvaged NYC pin oak*) W W
- Black (salvaged NYC pin oak*) B W
- Custom C U

* When available, we salvage wood from NYC's fallen street and park trees to make our Pillar collection.

BULB

- Tala Sphere I E-12 D 2 W
- Dim-to-Warm 2000k-2800k

